

B-TRAY

Hotel supplies

Catalogue 2025 | BTRAY.COM



B-TRAYding Nederland BV
Laan van Vredenoord 33
2289 DA RIJSWIJK
The Netherlands

+31 (0)23 542 12 12
info@btray.com
www.btray.com

© 2025 B-TRAYding Nederland BV
All rights reserved.



Welcome
AND BE INSPIRED.



Contents

Welcome to B-TRAY	4
B-TRAY's pros	5
The secret of our succes	6
Environmental commitment	7
Worldwide projects	8
Customized	10
Leatherette collection	12

<i>The hotel room</i>	14
Hospitality trays (trays, kettles, coffee machines and accessories)	15
Ironing products (ironing centres, ironing boards, accessories and irons)	38
Luggage racks	44
Desk accessories and security & safety products	54

<i>The bathroom</i>	64
Hair dryers	65
Weighing scales	68
Cosmetic mirrors	70



Welcome at B-TRAY



B-TRAY offers a carefully selected mix of in-house designed and manufactured hotel room accessories and products from leading global manufacturers and suppliers. Our dedication goes beyond enhancing the comfort and convenience of your hotel guests' experience; we also ensure that each product adds a touch of luxury to your rooms.

With over 17 years of experience, we really know how to create a wow factor for our clients and their guests. Our commitment to consistent quality and meticulous attention to detail is evident in every aspect of our work, ensuring the perfect look and feel. Only the finest raw materials are selected to produce our products, guaranteeing reliability, safety, and durability for extensive hotel use, without compromising their luxurious appearance.

It's not only the excellence of our products that stands out, but the exceptional service we provide as well. We take pride in our excellent service and proactive approach, always anticipating the needs of our clients and staying a step ahead. Our reputation for outstanding service has allowed us to proudly serve more than 100 countries!

Please take a look around, and be inspired. We look forward to hear from you and to surprise you with our offer.

Bas Rontetaps

Founder | CEO | Managing Director





+ Unmatched Quality

B-TRAY is synonymous with top quality, choosing only the finest raw materials that ensure reliability, safety, and endurance for extensive hotel use. We confidently back our products with a 2-year warranty.

+ Excellent Service

Customers appreciate us for our outstanding service and proactive approach. Recognized for our rapid response, we guarantee a reply to inquiries, quotes, or issues within one working day (and often within just two hours).

+ Swift Delivery

Our warehouse (based in The Netherlands) is fully stocked, ready for immediate dispatch of our B-TRAY products (95% of cases). We partner with trusted logistics for speedy global delivery.

+ Competitive Pricing

Thanks to our inhouse-design, production, and sales, we maintain highly competitive pricing without compromising on quality.

+ Certified Safety

Our products undergo extensive safety tests and are certified by leading agencies like Intertek and Bureau Veritas, ensuring the safety of your guests and staff.

+ Eco-Friendly Products

B-TRAY hotel supplies are created with our planet in mind, optimizing every detail from packaging to power usage to ensure environmental protection.



Our secret? Our own well-stocked warehouse

Bas Ronteltap: “We are proud to deliver our products worldwide with speed and efficiency. The secret of our success is our own, large and well-stocked Netherlands-based warehouse, which provides a total storage capacity of 650 pallets (that's more than 60,000 products!). It enables us to ship our orders immediately, whether it concerns one or more than 500 pieces. We don't rely on third parties, that's a great advantage!”

Thanks to our trustworthy logistic partners, we can ship our orders in no time. Our own warehouse provides direct logistic services for a fast and secure delivery. We deliver them at the right time and place in a cost-effective way and to the satisfaction of our customers.”

Nothing too remote for B-TRAY

Our products can reach any corner of the world, even the most isolated places. From New Caledonia to Bora Bora, there is no place too remote for B-TRAY!



B-TRAY's environmental commitment

As a company, our goal is to deliver high-quality products for the hotel and hospitality industry while minimizing the impact on our planet. We aim to work with recycled raw materials and minimize harmful packaging (less plastics, biodegradable packaging, etc.).

As tree planting is a vitally important component in the fight against climate change and biodiversity loss, we partnered with WeForest, an international organization dedicated to planting trees and bringing back forests to make the earth cooler, alleviate poverty, and restore ecosystems. For every five wooden hospitality trays and three luggage racks that we sell, we plant a tree in Zambia or India.

B-TRAY is also affiliated with WeCycle, a Dutch non-profit organisation (WEEE recycling network). WeCycle ensures waste electrical equipment is collected responsibly and optimally processed into new raw materials. This helps us support a circular economy.

Worldwide projects

With the help of our large network of international clients, hospitality professionals and resellers, we are proud to do business in more than 100 countries. Our reference list includes some of the finest hotels in the world.

In addition to (international) hotel chains, individual hotels, and cruise companies, we are increasingly supplying service-oriented institutions such as hospitals, nursing homes, and universities.



Hotel chains we take pride in working with

Highlighted brands



Customized

B-TRAY offers a wide range of luxury hotel room products, but we can also customize them to suit your needs. Our products are the result of our inspiration and creativity. We challenge ourselves to achieve the highest standards of technical and aesthetic excellence. That's why we can turn your ideas into reality, and customize our products to fit your vision and style. You can choose the colour, size, or shape that you prefer.

We collaborate with experts who share our passion and attention to detail. This way, you can enjoy the beauty of the product without worrying about the quality. We use the finest materials, finishes, and manufacturing processes to ensure your satisfaction.

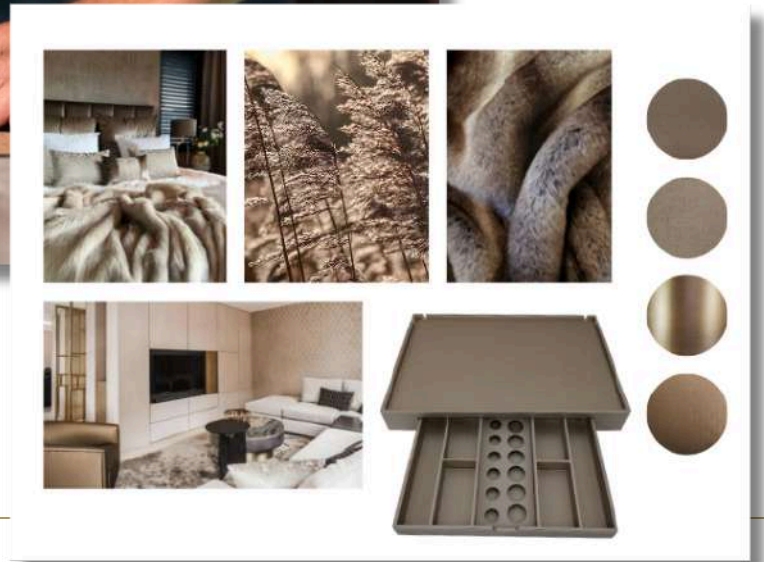
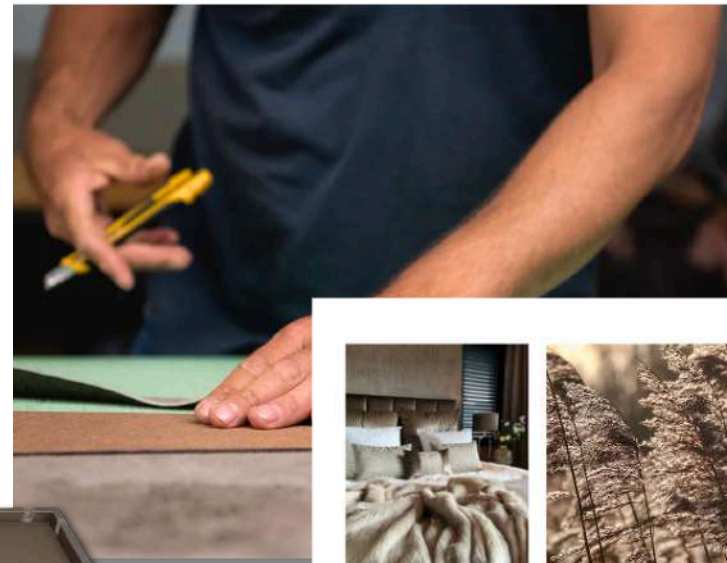
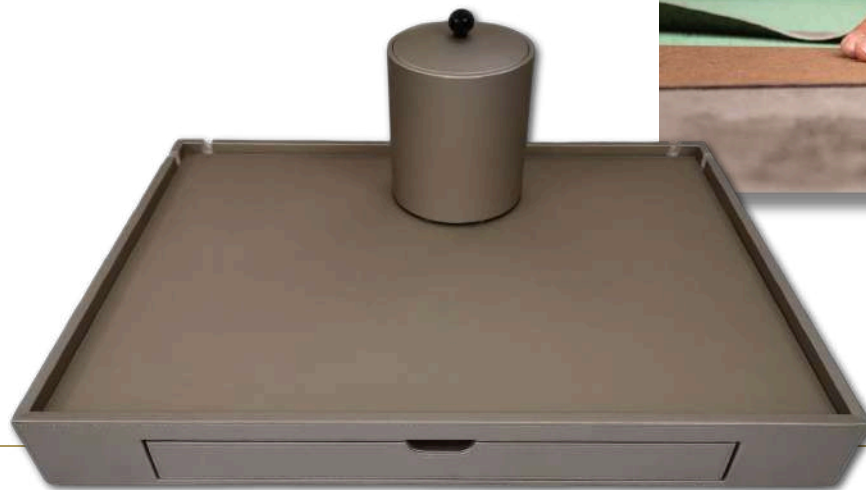

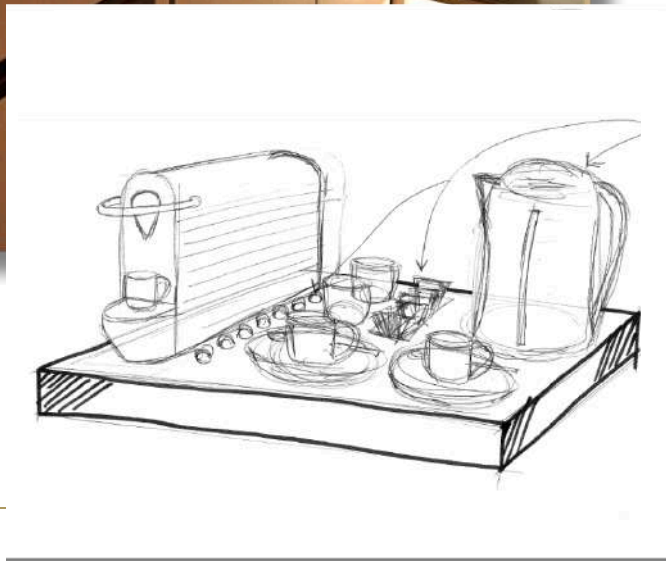

We have a limitless selection of bespoke solutions. Our bespoke hospitality trays are available in solid beech wood, beech veneer or faux leather, and can be supplied in any colour, size or shape of your choice. We can also provide bespoke luggage racks in various sizes and finishes.

Based on your requirements we will make a proposal and work out a (3D) visualization.

For a personal touch



Leatherette collection

Infuse your hotel rooms with a touch of sophistication with our exquisite faux leather accessories. Our collection spans from refined hospitality trays to stylish waste bins, and from luxurious ice buckets to sleek tissue box covers. Each accessory is expertly crafted from premium faux leather and boasts consistent colour stitching for a flawless finish. Additionally, we offer personalization options to feature your hotel's branding.

Our offerings are not limited to the standard collection. We are at your service to source additional faux leather items or to modify our existing products according to your unique requirements, including alterations in size, colour, or design.

Please find below our collection of faux leather products in warm beige. The harmonious blend of natural shades and organic design accents renders this collection a perfect choice for beachfront resorts and nature-themed hotels. These accessories are designed to amplify the comfort and relaxation of your guests, making their holiday retreat all the more memorable.

Tissue box SWEEP, hospitality tray SPACE, ice bucket SLUSH, waste bin SUMO, tissue box SHAPE and hospitality tray SNAP with basic tray and condiment box. All leatherette products are available in warm beige or black.



Keep ice cubes frozen
with our faux leather
ice bucket SLUSH





14

The hotel room

A hotel room is more than just a place to sleep; it's also a location to meet, work, and relax. Even the smallest details contribute to the ultimate experience of your guests.

With our help, your guests can enjoy a good cup of coffee or tea in their own hotel room with our high-quality kettles and coffee machines, and our convenient and stylish welcome trays with matching accessories. Guests can also enjoy cold drinks with our ice buckets. And don't worry if they spill their drink, because our tissue boxes are always nearby!

15

Hospitality trays

The ultimate coffee and tea experience

Making a cup of coffee or tea in the hotel room is essential for a great hotel experience. It's usually the first thing guests do when they check in, and also a vital part of their morning ritual. Therefore, a hospitality tray is a welcome addition to any hotel room!

B-TRAY provides the ultimate in-room coffee and tea experience with a variety of unique Dutch designed hospitality trays.

Our models range from affordable to deluxe options. Choose from our standard product line or get in touch with us if you prefer a bespoke hospitality tray.





	SUPREME	SPACE	SIGNUM	SLIM	SMART
Star level	5	5	5	4	4
Dimensions (W x D x H)	460 x 370 x 40mm	315 x 415 x 78mm	365 x 240 x 40mm	258 x 258 x 40mm	265 x 190 x 84mm
Material	MDF	Faux leather	MDF or solid beech	MDF	Beech veneer
Available colours	Black	Black or warm beige	Black, white or natural	Black	Black
Ultra-compact design				✓	✓
Integrated kettle base	✓		✓	✓	
Space for coffee machine	✓	✓			
Anti-theft cable fixture	✓		✓	✓	
Wire guidance		✓			✓
Bespoke possibilities	MOQ 200pcs	MOQ 200pcs	MOQ 200pcs	MOQ 200pcs	MOQ 500pcs
Compartments	3 + 6	4	3	1 + 3	4
A5 leaflet holder (optional)	✓		✓		
Drip tray for used tea bags					
Furniture protection gliders	✓	✓	✓	✓	✓
Price level	€€€	€€€	€€	€€	€€

Kettle options					
0.5L-STAR /-BLACK (plug: EU, UK, Swiss)	✓	✓	✓	✓	✓
1L-SALSA (plug: EU, UK, Swiss)	✓	✓	✓	✓	✓
1L-STYLE (plug: EU, UK, Swiss)	✓	✓	✓	✓	✓
1L-SOHO (plug: US)	✓	✓	✓	✓	✓
Your own hotel kettle	Base max. 143mm	✓	Base max. 143mm	Base max. 143mm	✓



	SIESTA	SNAP	STAY	SQUARE	SENSE
Star level	4	3	3	3	3
Dimensions (W x D x H)	432 x 362 x 40mm	417 x 320 x 55mm / 320 x 320 x 63mm	356 x 240 x 38mm	258 x 258 x 38mm	455 x 228 x 38mm
Material	ABS	Faux leather	ABS with wood structure	ABS with wood structure	ABS with wood structure
Available colours	Black	Black or warm beige	Black	Black	Black
Ultra-compact design		Yes (with condiment box on top)		✓	
Integrated kettle base	✓		✓	✓	✓
Space for coffee machine	✓	✓			
Anti-theft cable fixture	✓		✓	✓	✓
Wire guidance					
Bespoke possibilities		MOQ 200pcs			
Compartments	3 + 4	3	3	1+3	4
A5 leaflet holder (optional)	✓		✓		
Drip tray for used tea bags	✓		✓	✓	✓
Furniture protection gliders	✓		✓	✓	✓
Price level	€€	€	€	€	€

Kettle options					
0.5L-STAR /-BLACK (plug: EU, UK, Swiss)	✓	✓	✓	✓	✓
1L-SALSA (plug: EU, UK, Swiss)	✓	✓	✓	✓	✓
1L-STYLE (plug: EU, UK, Swiss)	✓	✓	✓	✓	✓
1L-SOHO (plug: US)	✓	✓	✓	✓	✓
Your own hotel kettle	Base max. 143mm	✓	Base max. 143mm	Base max. 143mm	Base max. 143mm

Mix & Match

With B-TRAY, you have the opportunity to design your own hospitality tray. Choose from numerous unique models across various price ranges, different types of kettles, a coffee machine compatible with Nespresso®, and optional hotel porcelain cups.

Simply create your ideal coffee and tea tray based on your room's decor and budget.

We offer more than 300 different combinations!

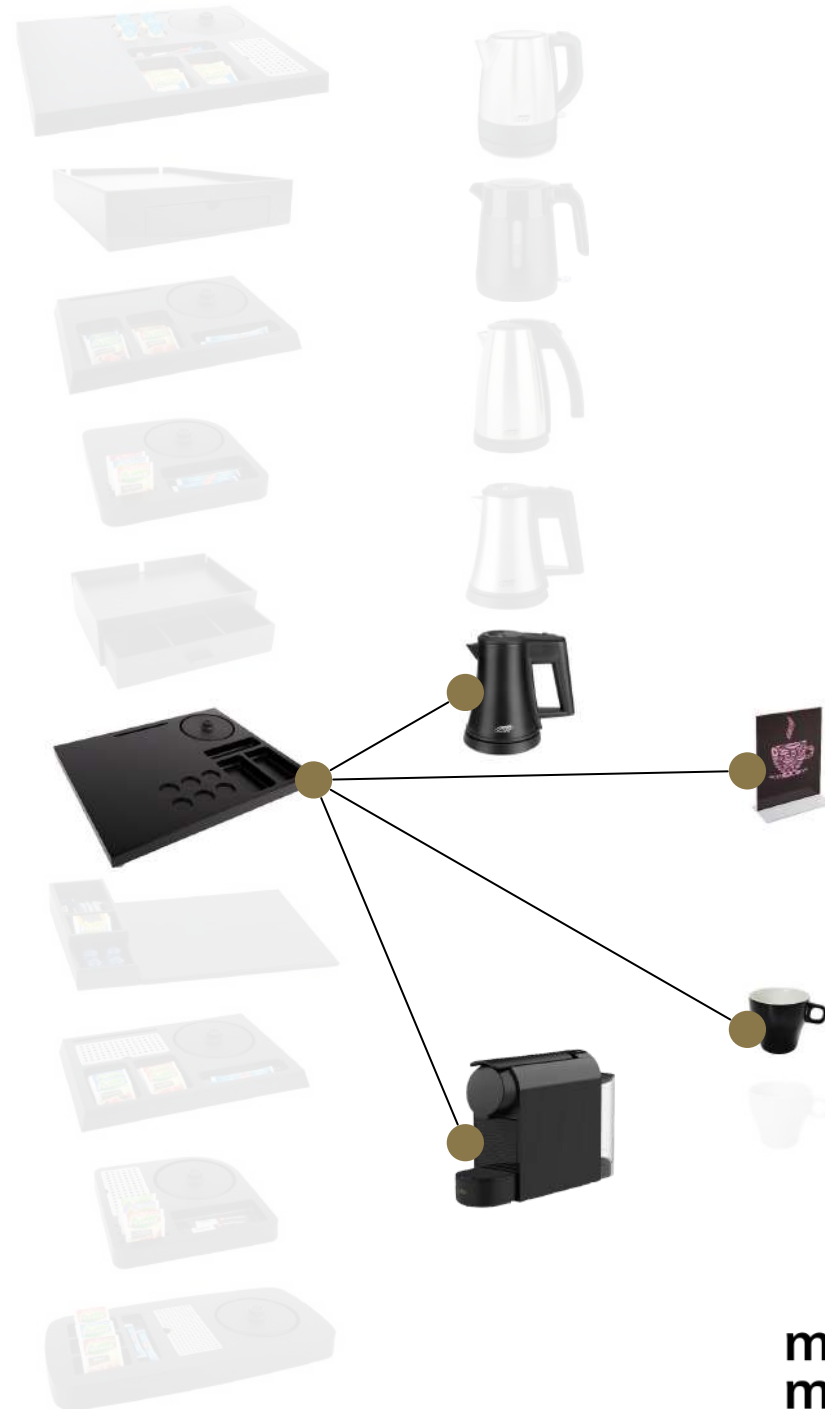

Configurator

With the B-TRAY configurator on our website, you can easily design your favourite hospitality tray and view it directly online.

Just choose the tray and water kettle you like, and decide if you want to include coffee cups.

When you are happy with the design, you can send us a quotation request for the selected items.

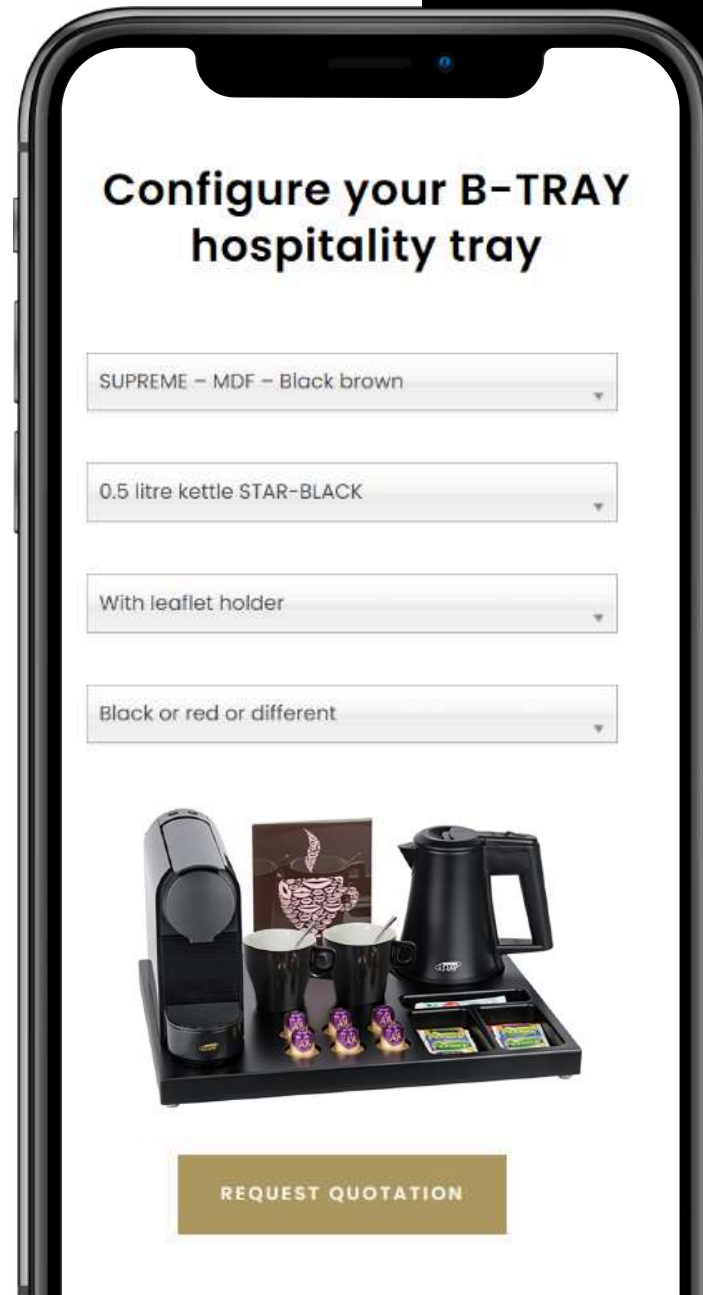



SUPREME hospitality tray

WITH SPACE FOR A KETTLE, COFFEE MACHINE, LEAFLET HOLDER AND CUPS

- Made of high-quality wood (MDF) with a black finish
- Ultra-strong lacquer to minimize scratches and stains
- Anti-theft: cable of kettle power base can be connected to the tray
- Compartments for coffee and tea ingredients
- Easy to clean due to rounded edges
- Bespoke possibilities (MOQ 200 pieces)
- B-TRAY plants 1 tree for every 5 wooden hospitality trays sold
- A 2-year warranty



DIMENSIONS

Tray: 460 x 370 x 40mm (W x D x H)
 Height including STAR kettle: 212mm
 Height including STYLE kettle: 252mm
 Height including SALSA kettle: 230mm
 Space for coffee machine: max. 130 x 370mm (W x D)

Compartments:

For tea bags (2x): 70 x 125 x 25mm (W x D x H)
 For sugar/milk sticks (1x): 150 x 40 x 25mm (W x D x H)
 For coffee capsules (6x): Ø40mm

COLOUR  Black



mix+ match

OPTIONAL

Kettle: STAR, STAR-BLACK, SALSA, STYLE or SOHO
 Coffee machine: START (black)
 A5 leaflet holder: SHOW
 Hotel porcelain cup: SPRING (black or white)

Request a quotation



SPACE hospitality tray



SUITABLE FOR NESPRESSO® INISSIA · PIXIE · CITIZ · ZENIUS · ESSENZA · VERTUO

- Made of durable faux leather
- Space for our START coffee machine and all commonly used Nespresso® machines
- Large drawer for dust-free storage of coffee and tea ingredients
- 2 removable inlays to hold Nespresso® capsules perfectly
- Also suitable for your own hotel kettle
- Wire guidance to the left, to the right and backwards
- Bespoke possibilities (MOQ 200 pieces)
- A 2-year warranty

Foam inlay 1: with 4 inserts for professional Nespresso® Grands Crus or Vertuo capsules.

Foam inlay 2: with 6 inserts for original Nespresso® capsules.

mix+match

OPTIONAL

Kettle: STAR, STAR-BLACK, SALSA, STYLE or SOHO

Coffee machine: START (black)

Hotel porcelain cup: SPRING (black or white)

DIMENSIONS

Tray: 315 x 415 x 78mm (W x D x H)

Inner size: 300 x 400mm (W x D)

Compartments: (W x D x H)

60 x 275 x 45mm (2x) – with 2 inlays

75 x 135 x 45mm (2x)

COLOURS

Black or warm beige



dutch design.

Request a quotation



SIGNUM hospitality tray

LUXURIOUS WELCOME TRAY WITH OPTIONAL LEAFLET HOLDER

- Compact size, space saving
- Made of high-quality solid beech or MDF
- Ultra-strong lacquer to minimize scratches and stains
- Anti-theft: cable of kettle power base can be connected to the tray
- Easy to clean due to rounded edges
- Bespoke possibilities (MOQ 200 pieces)
- B-TRAY plants 1 tree for every 5 wooden hospitality trays sold
- A 2-year warranty

DIMENSIONS

Tray: 365 x 240 x 40mm (W x D x H)
 Height including STYLE kettle: 252mm
 Height including SALSA kettle: 230mm
 Height including STAR kettle: 212mm

WOOD COLOURS

Natural beech, white or black

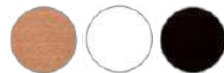

Compartments: (W x D x H)
 For tea bags: 69 x 120 x 25mm (2x)
 For sugar/milk sticks: 140 x 35 x 25mm (1x)



mix+ match

OPTIONAL

Kettle: STAR, STAR-BLACK, SALSA, STYLE, or SOHO
 A5 leaflet holder: SHOW
 Hotel porcelain cup: SPRING (black or white)



Request a quotation

SLIM hospitality tray

LUXURIOUS WOODEN COFFEE & TEA TRAY WITH SMALL 'FOOTPRINT'

- Made of high-quality MDF
- Ultra-strong black lacquer to minimize scratches and stains
- Slim size, space saving
- Anti-theft: cable of kettle power base can be connected to the tray
- Easy to clean due to rounded edges
- 4 furniture protection gliders
- Bespoke possibilities (MOQ 200 pieces)
- B-TRAY plants 1 tree for every 5 wooden hospitality trays sold
- A 2-year warranty

DIMENSIONS

Tray: 258 x 258 x 40mm (W x D x H)
Height including STYLE kettle: 252mm
Height including STAR kettle: 212mm
Height including SALSA kettle: 230mm

Compartments: (W x D x H)
For tea bags: 70 x 6 x 20mm (3x)
For sugar/milk sticks: 142 x 70 x 25mm (1x)

COLOUR  Black



Space for 2 coffee cups



3 slots for vertical storage of tea bags



Anti-theft cable lock

mix+ match

OPTIONAL

Kettle: STAR, STAR-BLACK, SALSA, STYLE or SOHO
Hotel porcelain cup: SPRING (black or white)

Request a quotation



Design your own drawer with removable dividers



SMART hospitality tray

COMPACT TRAY WITH A UNIQUE DRAWER WITH REMOVABLE DIVIDERS

- Made of high-quality plywood with beech veneer
- Black lacquer (waterproof)
- Slim size, space saving
- Drawer for dust-free storage of condiments
- Design your own drawer with removable dividers
- Equipped with 4 furniture protection gliders
- B-TRAY plants 1 tree for every 5 wooden hospitality trays sold
- A 2-year warranty

DIMENSIONS

Tray: 265 x 190 x 84mm (W x D x H)
 Height including STYLE kettle: 300mm
 Height including STAR kettle: 260mm
 Height including SALSA kettle: 273mm

Adaptable compartments: (W x D x H)
 76 x 81 x 40mm (2x)
 76x 168 x 40mm (2x)

COLOUR  Black

mix+ match

OPTIONAL

Kettle: STAR, STAR-BLACK, SALSA, STYLE or SOHO
 Hotel porcelain cup: SPRING (black or white)



Tray can be used with your own hotel kettle (max. Ø173mm)



Request a quotation



SIESTA hospitality tray

SPACE FOR COFFEE MACHINE, KETTLE, CUPS AND LEAFLET HOLDER

- Made of heat-resistant ABS, colour black
- Designed with enough space for a (Nespresso®) coffee machine, water kettle, cups and A5 leaflet holder
- Compartments for condiments (3x) and coffee capsules (4x)
- Removable stainless steel 'drip tray' for used tea bags/spoons
- Available with integrated A5 leaflet holder (removable)
- Anti-theft system for water kettle power base
- A 2-year warranty

COLOUR  Black



mix+ match

OPTIONAL

Kettle: STAR, STAR-BLACK, SALSA, STYLE or SOHO

Coffee machine: START (black)

A5 leaflet holder: SHOW

Hotel porcelain cup: SPRING (black or white)

DIMENSIONS

Tray: 432 x 362 x 40mm (W x D x H)

Height including STAR kettle: 212mm

Height including SALSA kettle: 230mm

Height including STYLE kettle: 252mm

Compartments:

For tea bags (2x): 70 x 115 x 23mm (W x D x H)

For sugar/milk sticks (1x): 150 x 40 x 23mm (W x D x H)

For coffee capsules (4x): Ø40mm

Request a quotation



SNAP hospitality tray

MULTIFUNCTIONAL & FLEXIBLE | DESIGN YOUR OWN SETUP



- Made of high-quality faux leather
- Main tray and matching condiment box (available both as a complete set and individually)
- Condiment box can be snapped in place on both the left or the right side of the main tray (unique magnetic click system)
- A 2-year warranty

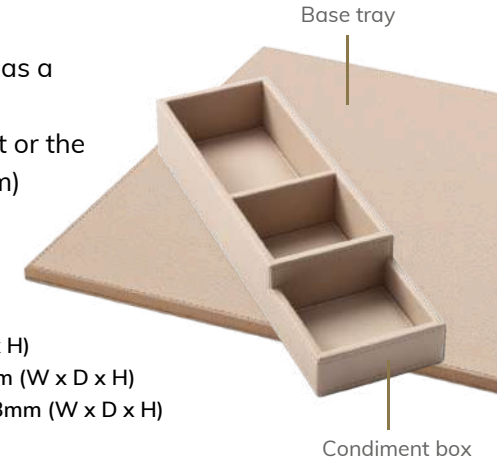

DIMENSIONS

Main tray: 320 x 320 x 8mm | Condiment box: 97 x 320 x 55mm (W x D x H)
 Complete set with condiment box on the left/right side: 417 x 320 x 55mm (W x D x H)
 Complete set with condiment box on top of the main tray: 320 x 320 x 63mm (W x D x H)
 Height including STAR kettle: 203mm | STYLE: 238mm | SALSA: 211mm
 Height including START coffee machine: 218mm
 Compartments of box: 83 x 137 x 45mm | 83 x 80 x 45mm | 83 x 80 x 25mm (W x D x H)

COLOURS

Black or warm beige



mix+ match

OPTIONAL

- Main tray (black or warm beige)
- Condiment box (black or warm beige)
- Kettle: STAR, STAR-BLACK, STYLE, SALSA or SOHO
- Coffee machine: START (black)
- Hotel porcelain cup: SPRING (black or white)



Set up 1: Box on top of tray, on the left side



Set up 2: Box on top of tray, in the middle



Set up 3: Box on top of tray, on the right side



Set up 4/5: Box next to tray, on the left/right side

Request a quotation



STAY hospitality tray

HEAT-RESISTANT ABS TRAY WITH 'DRIP TRAY' FOR USED TEA BAGS

- Made of heat-resistant ABS with a wood structure finish
- Available in stylish black colour
- Removable stainless steel perforated 'drip tray' for used tea bags and spoons
- 3 compartments for presentation of condiments
- Anti-theft system for water kettle power base
- Optional A5 leaflet holder (removable)
- Easy to clean due to rounded edges
- A 2-year warranty

DIMENSIONS

Tray: 356 x 240 x 38mm (W x D x H)
Height including STAR kettle: 210mm

Compartments: (W x D x H)
For tea bags: 69 x 104 x 20mm (2x)
For sugar/milk sticks: 140 x 35 x 20mm (1x)

COLOUR  Black



mix+
match

OPTIONAL

Kettle: STAR, STAR-BLACK, SALSA, STYLE or SOHO
A5 leaflet holder SHOW
Hotel porcelain cup: SPRING (black or white)

Request a quotation



SQUARE hospitality tray

ULTRA-COMPACT COFFEE AND TEA TRAY OF DURABLE ABS

- Made of heat-resistant ABS with a wood structure finish
- Available in stylish black colour
- Ultra-compact design
- Removable stainless steel perforated 'drip tray' for used tea bags and spoons
- Anti-theft system for water kettle power base
- 4 furniture protection gliders
- Easy to clean due to rounded edges
- Budget friendly
- A 2-year warranty

DIMENSIONS

Tray: 258 x 258 x 38mm (W x D x H)

Height including STYLE kettle: 250mm

Height including SALSA kettle: 228mm

Height including STAR kettle: 210mm

Compartments: (W x D x H)

For tea bags: 70 x 6 x 20mm (3x)

For sugar/milk sticks: 140 x 60 x 20mm (1x)

COLOUR  Black

mix+ match

OPTIONAL

Kettle: STAR, STAR-BLACK, SALSA, STYLE or SOHO

Hotel porcelain cup: SPRING (black or white)



Space for 2 coffee cups



Request a quotation



SENSE hospitality tray

BUDGET-FRIENDLY TRAY OF DURABLE ABS PLASTIC

- Made of heat-resistant ABS with a wood structure finish
- Removable stainless steel perforated 'drip tray' for used tea bags and spoons
- Anti-theft system for water kettle power base
- Easy to clean due to rounded edges
- 4 furniture protection gliders
- Budget-friendly design
- A 2-year warranty

DIMENSIONS

Tray: 455 x 228 x 38mm (W x D x H)

Height including SALSA kettle: 230mm

Height including STAR kettle: 210mm

Height including STYLE kettle: 250mm

Compartments: (W x D x H)

For tea bags: 80 x 45 x 20mm (3x)

For sugar/milk sticks: 35 x 149 x 15mm (1x)

COLOUR  Black



mix+ match

OPTIONAL

Kettle: STAR, STAR-BLACK, SALSA, STYLE or SOHO

Hotel porcelain cup: SPRING (black or white)

Request a quotation



SPECIAL hospitality tray

BESPOKE HOSPITALITY TRAYS – DESIGN YOUR OWN TRAY



B-TRAY offers a wide range of hospitality trays in various colours. But we design and manufacture trays on request too. Thanks to our design team we can provide bespoke solutions, to create the perfect hospitality tray for your hotel rooms. Our special trays are available in solid wood, MDF, beech veneer or faux leather and can be supplied in any colour, size or shape of your choice!

SOME EXAMPLES OF BESPOKE POSSIBILITIES

- Material: solid wood, MDF, beech veneer or faux leather
- Size, shape and colour: your own design
- With anti-theft system for kettle power base
- With hotel logo

MINIMUM ORDER QUANTITY

- MDF or solid wood: 200 pieces
- Faux leather: 200 pieces
- Beech veneer: 500 pieces



Design your own tray

Request a quotation

HOTEL WATER KETTLES



	STAR & STAR-BLACK ECO 	SALSA 1L BUDGET	STYLE 1L	SOHO 1L
Capacity	0.5 litre	1 litre	1 litre	1 litre
Power	1000W	1500W	1500W	1200W
Voltage and frequency	220~240V and 50/60Hz	220~240V and 50/60Hz	220~240V and 50/60Hz	120V and 60Hz
Low water and energy consuming	✓			
Material	304 stainless steel	Polypropylene (heating element 304SS)	304 stainless steel	304 stainless steel (D11)
Indicator light (safety)	✓	✓	✓	✓
Auto shut-off (safety)	✓	✓	✓	✓
Boil dry protection (safety)	✓	✓	✓	✓
Genuine British STRIX controller (safety)	✓	✓	✓	✓
Concealed heating element (easy to clean)	✓	✓	✓	✓
Removable anti-lime filter (easy to clean)	✓	✓	✓	✓
360° cordless operation (user friendly)	✓	✓	✓	✓
Cable length	75cm	73cm	75cm	90cm (35.4")
Height	19.5cm	20.3cm	23cm	20cm (7.9")
Diameter power base	14cm	14cm	14.3cm	14cm (5.5")
Type of plug	Euro, UK or Swiss	Euro, UK or Swiss	Euro, UK or Swiss	US
Certification	CE, CB, GS, and RoHS (Intertek)	CE, CB, GS (Bureau Veritas) RoHS (Intertek)	CE, CB, GS, and RoHS (Intertek)	cETLus listed (Intertek), Hospitality Rated

START coffee machine

COMPATIBLE WITH NESPRESSO® STYLE CAPSULES

- Sleek and modern design
- Ultra-compact size, width only 93mm
- Made of durable ABS plastic, colour glossy black
- 20 bar high pressure pump, made in Italy
- Removable drip tray for small and large coffee cup
- Practical water tank, easy to remove and to clean
- Safety features: indicator light and automatic switch-off
- Easy to use with just 2 buttons (Espresso or Lungo)
- Spare parts can be bought separately
- A 2-year warranty

COLOUR  Glossy black

TYPE OF PLUG
EU | UK | Swiss



TECHNICAL SPECIFICATIONS

Dimensions: 93 x 342 x 210mm (W x D x H)
 Tank capacity: 0.5 litre
 Power: 1200W
 Voltage: 220~240V
 Weight: 2.4kg
 Electrical insulation: Class 1

SPRING coffee cup

DURABLE HOTEL PORCELAIN

- Made of high-quality hotel porcelain
- Dishwasher safe
- Capacity of 20cl
- A 2-year warranty

[Request a quotation](#)

DIMENSIONS

Height: 73mm
Diameter opening: 80mm
Diameter bottom: 52mm

COLOURS

White or black



SHINE tea spoon

STAINLESS STEEL SPOON

- Sleek and modern design
- Made of 18/11 stainless steel
- A 2-year warranty

[Request a quotation](#)

SIZE

Length: 11.5cm

COLOUR





STORE capsule box

WITH REVERSIBLE HOLDER FOR 4 OR 6 NESPRESSO® CAPSULES

- Box to store coffee capsules, spoons and sugar/milk sticks
- Removable, double-sided inlay for 4 or 6 classic Nespresso® capsules
- Made of faux leather or MDF with high-quality lacquer
- Our faux leather version pairs perfectly with the SNAP or SWITCH main tray to form a comprehensive hospitality tray
- Dust-free design with lid, easy maintenance
- A 2-year warranty

DIMENSIONS (W x D x H)

Box of faux leather:

Box closed: 170 x 170 x 65mm

Compartment 1 for spoons or sugar/milk sticks: 150 x 44 x 30mm

Compartment 2 for inlay or other condiments: 147 x 97 x 30mm

Box of MDF:

Box closed: 165 x 165 x 60mm

Compartment 1 for spoons or sugar/milk sticks: 147 x 44 x 30mm

Compartment 2 for inlay or other condiments: 147 x 97 x 30mm

COLOURS

Black (MDF or faux leather)

Warm beige (faux leather)

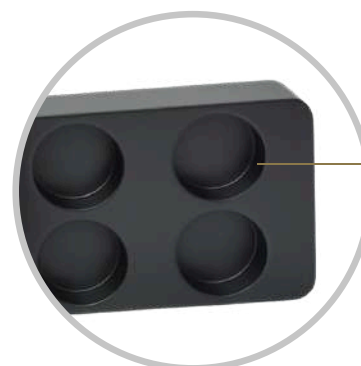

Reversible inlay

Side 1: 4 holes (Ø38mm)

Side 2: 6 holes (Ø38mm)



Request a quotation



dutch
design.

SNAP condiment box

FAUX LEATHER STORAGE BOX FOR COFFEE AND TEA INGREDIENTS

- Made of high-quality faux leather
- Functional with an elegant look
- Available in two different colours: warm beige or black
- 3 compartments to store coffee capsules, tea bags and sugar sticks
- Water repellent and easy to clean
- Pairs perfectly with the SNAP or SWITCH main tray to form a comprehensive hospitality tray
- Anti-slip bottom
- A 2-year warranty

DIMENSIONS (W x D x H)

97 x 320 x 55mm

Compartments:

- 83 x 137 x 45mm
- 83 x 80 x 45mm
- 83 x 80 x 25mm



The SNAP condiment box pairs perfectly with our SWITCH main tray (dual-colour design).

COLOURS

Black or warm beige



mix+
match

OPTIONAL

Main tray: SNAP or SWITCH (black or warm beige)



It also pairs seamlessly with our SNAP main tray (available in black or warm beige).

Request a quotation



SNAP main tray (small)

DUAL FUNCTION: HOSPITALITY TRAY OR DESK BLOTTER

- Made from premium faux leather
- Can be used as a coffee and tea tray or as a desk blotter
- Available in two different colours: warm beige or black
- Functional with an elegant look
- Pairs perfectly with other B-TRAY products like the SLUSH ice bucket, SWEEP/SHAPE tissue boxes and SNAP condiment box
- Combines elegance with practicality, making it a perfect addition to any hospitality setting or office desk
- Water repellent and easy to clean
- A 2-year warranty

DIMENSIONS

320 x 320 x 8mm (W x D x H)

COLOURS

Black or warm beige



mix+
match

OPTIONAL

Condiment box: SNAP or STORE (black or warm beige)

Ice bucket: SLUSH (black or warm beige)

Tissue box: SWEEP or SHAPE (black or warm beige)

Kettle: STAR, STAR-BLACK, STYLE, SALSA or SOHO

Coffee machine: START (black)

Hotel porcelain cup: SPRING (black or white)



Request a quotation



SWITCH main tray (XL) | desk blotter

DUAL FUNCTION: HOSPITALITY TRAY OR DESK BLOTTER

- Made from premium faux leather
- Can be used as a **coffee and tea tray** or as a **desk blotter**
- Reversible design with one side in warm beige and the other in black, allowing customers to choose their preferred colour
- Pairs perfectly with other B-TRAY products like the SLUSH ice bucket, SWEEP/SHAPE tissue boxes, SNAP condiment box and STORE coffee capsule box
- Combines elegance with practicality, making it a perfect addition to any hospitality setting or office desk
- Water repellent and easy to clean
- A 2-year warranty

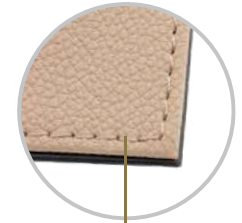

Reversible design with two colour options



DUAL
funtion

DIMENSIONS

500 x 400 x 8mm (W x D x H)

COLOUR/STRUCTURE



Side 1: warm beige / lychee grain
Side 2: black / smooth

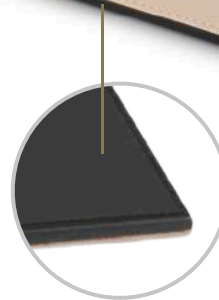

mix+
match

OPTIONAL

Condiment box: SNAP or STORE (black or warm beige)

Ice bucket: SLUSH (black or warm beige)

Tissue box: SWEEP or SHAPE (black or warm beige)

Kettle: STAR, STAR-BLACK, STYLE, SALSA or SOHO

Coffee machine: START (black)

Hotel porcelain cup: SPRING (black or white)



Request a quotation



38

Ironing solutions

Smooth out your guests' experience

An ironing centre is a vital accessory for any hotel bedroom. It helps hotel guests, especially business guests, to iron their clothes after travelling. Our ironing products will assist them in looking their best for any occasion.

B-TRAY offers a wide range of ironing solutions: from complete ironing centres to individual irons and ironing boards. We have it all! Our products are specially made for the hotel and hospitality industry, guaranteeing safety and hotel-quality.



B-TRAY



22/24cm



SMOOTH ironing centre

COMPLETE IRONING SET WITH STEAM IRON OR DRY IRON AND ORGANIZER

- The most compact ironing station for hotels
- Light weight, so excellent portability and easy to store
- Adjustable in height, 7 levels from 62 to 78cm
- Stable board with rubber anti-slip feet
- Strong and sturdy black frame
- Easily replaceable fire-retardant elastic cover
- Anti-theft: cable can be connected to the board
- 360° rotating iron organizer for left and right-handed guests
- Integrated solid hook for easy storage on a rail
- Available with steam iron or dry iron (plug: EU, UK or Swiss)
- A 2-year warranty

dutch design.



[Request a quotation](#)

SPECIFICATIONS SMOOTH-STEAM

Size folded: 33 x 24 x 119.2cm (W x D x H)
 Size open: 107.5 x 33 x 79.2-95.2cm (W x D x H)
 Weight: 5.49kg

SPECIFICATIONS SMOOTH-DRY

Size folded: 33 x 22 x 118.6cm (W x D x H)
 Size open: 106.9 x 33 x 77.2-93.2cm (W x D x H)
 Weight: 5.11kg



- Cover Anthracite
- Frame Matt black



SMOOTH ironing board

ULTRA-COMPACT MESH FRAME IRONING BOARD

- The most compact ironing board for hotels
- Adjustable in height, 7 levels from 62 to 78cm
- Light weight (3.6kg), so excellent portability and easy to store
- Strong and sturdy black frame
- Stable board with rubber anti-slip feet
- The foot is clipped to secure it during movement
- Anti-theft: cable can be connected to the board
- Easily replaceable fire-retardant elastic cover
- Also available with steam or dry iron and organizer
- **A 2-year warranty**



- Cover Anthracite
- Frame Matt black

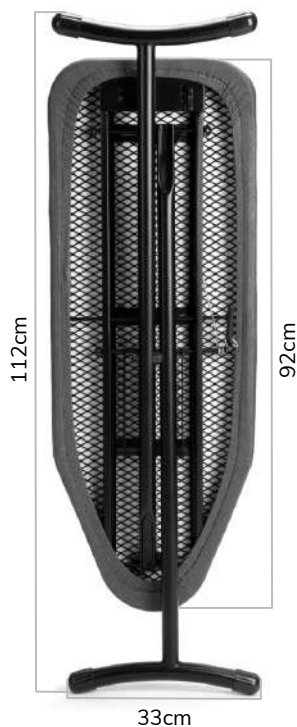

DIMENSIONS

Folded: 33 x 6.8 x 112cm (W x D x H)

Ironing surface: 92 x 33cm (W x D)

Height: 7 levels from 62 to 78cm

Anti-theft: cable can be connected to the board

Request a quotation

SMOOTH organizer

SPECIALLY DESIGNED FOR THE SMOOTH IRONING BOARD

- Made of durable steel
- Easy to attach with 2 butterfly screws (included)
- Designed with heat-resistant plastic caps to prevent sliding of the iron
- The integrated hook makes it easy to store the board on a rail
- 360° rotating, user friendly for left and right-handed guests
- Maintains the ironing surface due to the swivel mechanism
- Available in 2 sizes (for steam iron or dry iron)

Request a quotation

COLOUR  Matt black



SMOOTH cover

EASILY REPLACEABLE ELASTIC COVER

- Safe fire-retardant cover for hotels
- Replacement item for ironing board SMOOTH
- Fits perfectly on ironing board SMOOTH
- Strong padded quality in dark grey colour
- Extra thick sewn-in cotton felt
- Smooth binding edges to withstand frying
- The elastic cover is quick and easy to replace

Request a quotation

COLOUR  Anthracite





STEAM iron

HOTEL SAFETY IRON WITH POWERFUL STEAM FUNCTIONS

- Auto shut-off feature for extra safety and energy saving – 30 seconds unattended on soleplate and 8 minutes upright
- Adjustable thermostat and steam control
- Overheating safety protection
- Easy glide non-stick soleplate, extra large surface
- Special anti-drip prevents cooled steam drip
- Operating light for auto off and in use status
- Fast heat-up time with high performance
- Powerful vertical and horizontal steam burst
- Self-cleaning system and anti-calcification feature
- 360° revolving cable guard
- Ultra-long 3m cable with extra safe sealed plug
- CE, CB, GS and RoHS approved
- A 2-year warranty



DIMENSIONS

29 x 12 x 14cm (W x D x H)
Soleplate: 23 x 12cm (W x D)

TECHNICAL SPECIFICATIONS

Power: 1600W
Voltage: 220~240V
Frequency: 50/60Hz

OTHER SPECIFICATIONS

Weight: 1kg
Capacity tank: 200ml

[Request a quotation](#)

TYPE OF PLUG
EU | UK | Swiss

COLOUR  Black





DRY iron

SPECIALLY DESIGNED FOR HOTELS

- Auto shut-off feature for extra safety and energy saving – 30 seconds unattended on soleplate and 8 minutes upright
- Water saving and more eco friendly than a steam iron
- Adjustable thermostat for different garment ironing options
- Overheating safety protection
- Easy glide non-stick soleplate, easy maintenance
- Operating light for auto off and in use status
- Ergonomic handle
- Compact and lightweight
- 360° revolving cable guard
- Ultra-long 3m cable with extra safe sealed plug
- CE, CB, GS and RoHS approved
- A 2-year warranty

[Request a quotation](#)

TYPE OF PLUG
EU | UK | Swiss

COLOUR  Black



DIMENSIONS

26 x 10.5 x 12cm (W x D x H)
Soleplate: 19.8 x 10.5cm (W x D)

WEIGHT

725gr

TECHNICAL SPECIFICATIONS

Power: 1000W
Voltage: 220~240V
Frequency: 50/60Hz





44

Luggage racks

Too beautiful to hide in a closet

Our luggage racks are a great addition to any hotel room and we have a variety that matches any hotel style. Our suitcase stands are all durable, convenient, and stylish. You can choose from a classic design in beechwood or a modern design in stainless steel. They all fold away very easily to save space when not in use and are simple to set up.

But to be honest, we find our luggage racks too beautiful to hide away in a closet! A better option is to place them prominently in your hotel rooms for a beautiful finishing touch.

Looking for something unique? We can also customize our suitcase stands to meet your specific needs.





SPECIAL luggage rack

DESIGN YOUR OWN LUGGAGE RACK

B-TRAY offers a fine collection of stylish luggage racks. But we design and manufacture luggage racks on request too. Thanks to our design team we can provide bespoke solutions, to create the perfect luggage rack for your hotel rooms. Are you looking for a luggage rack with a different size? Or in a different colour? Or with personalized straps? Contact us for the possibilities!

A FEW EXAMPLES OF BESPOKE POSSIBILITIES

- Wood: beech wood, oak, RAL colour
- Steel: stainless steel, RAL colour, chrome finish, metallic
- Straps: nylon, leather, with logo, cover (instead of straps)
- Design: different shape, different size
- Custom branding: logo on frame, logo on straps

MINIMUM ORDER QUANTITY

- Wood: 100 pieces
- Steel: 300 pieces
- Embroidered nylon straps: 100 sets

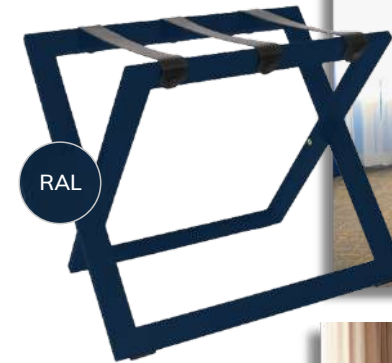

Different strap colour

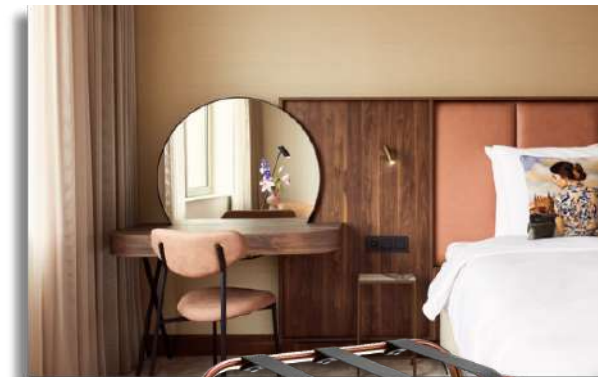

Copper



Logo embroidery

Request a quotation

LUGGAGE RACKS OF WOOD



	STAND	STAND+	SAMBA BUDGET
Frame colour	Black, walnut, natural beech or white	Black, walnut, natural beech or white	Black
Material	Solid beech wood	Solid beech wood	Solid beech wood
Nylon straps (standard)	Black or grey*	Black or grey*	Black (already attached)
Leather straps (optional)	Black, grey, cognac or white*	Black, grey, cognac or white*	
Made in Europe	✓	✓	
Dimensions			
Specials			
Different wood colour (MOQ 100 pcs)	✓	✓	
Embroidered nylon straps (MOQ 100 sets)	✓	✓	

*Easy to attach with 3 push buttons

LUGGAGE RACKS OF STEEL

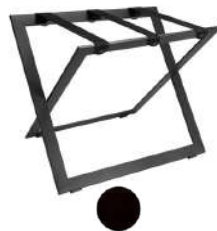

	STAND-STEEL	SCURO	SIXX BUDGET	SAFARI BUDGET
Frame colour	Stainless steel with brushed chrome finish	Matt black	Matt black	Silver, white or matt black
Material	Stainless steel	Steel	Steel	Steel
Nylon straps (standard)	Black or grey*	Black or grey*	Black or grey*	Black (already attached)
Leather straps (optional)	Black, grey, cognac or white*	Black, grey, cognac or white*	Black, grey, cognac or white*	
Made in Europe				
Dimensions				
Specials				
Different colour (MOQ 300 pcs)	✓	✓	✓	✓
Embroidered nylon straps (MOQ 100 sets)	✓	✓	✓	✓

*Easy to attach with 3 push buttons



STAND(+)⁺ luggage rack

DUTCH DESIGN SOLID WOODEN LUGGAGE RACK – MADE IN EUROPE

- Made of durable solid beech
- Available with or without wall protector
- Flat when folded up, depth only 5.5cm
- 3 strong exchangeable straps in nylon or genuine leather
- Bespoke possibilities (other wood colour or embroidered straps)
- Equipped with 4 floor protection gliders
- B-TRAY plants 1 tree for every 3 luggage racks sold
- A 2-year warranty

DIMENSIONS OPEN (W x D x H)

575 x 390 x 465mm (STAND without wall protector)

575 x 450 x 560mm (STAND+ with wall protector)

DIMENSIONS FOLDED (W x D x H)

575 x 55 x 590mm (STAND without wall protector)

575 x 55 x 700mm (STAND+ with wall protector)



Without or with wall protector

mix+ match

FRAME COLOURS

Black, walnut, natural beech or white



STRAP COLOURS

Nylon (black or grey) or leather (black, grey, cognac or white)



Easy to attach with 3 push buttons

Request a quotation

dutch
design.



SAMBA luggage rack

FOLDABLE LUGGAGE RACK OF BEECH WOOD - DUTCH DESIGN

- Sturdy and stable frame
- Made of durable solid beech
- Very flat when folded up, depth only 4.3cm
- Equipped with 4 floor protection gliders
- 4 strong fixed nylon straps
- B-TRAY plants 1 tree for every 3 luggage racks sold
- Budget-friendly model
- A 2-year warranty

Request a quotation

FRAME COLOUR

Black



STRAP COLOUR

Black nylon



DIMENSIONS OPEN (W x D x H)

500 x 430 x 480mm

DIMENSIONS FOLDED (W x D x H)

500 x 43 x 630mm





STAND-STEEL luggage rack

COMPACT STAINLESS STEEL LUGGAGE RACK – DUTCH DESIGN

- Made of welded stainless steel with brushed chrome finish
- Flat when folded up, depth only 5.5cm
- Fits your wardrobe perfectly
- 3 strong exchangeable straps in nylon or genuine leather
- Bespoke possibilities (customized straps with logo)
- Equipped with 4 floor protection gliders
- B-TRAY plants 1 tree for every 3 luggage racks sold
- A 2-year warranty

[Request a quotation](#)

DIMENSIONS OPEN (W x D x H)
575 x 390 x 465mm

DIMENSIONS FOLDED (W x D x H)
575 x 55 x 590mm

dutch
esign.

FRAME COLOUR

Stainless steel with brushed chrome finish



STRAP COLOURS

Nylon (black or grey) or leather (black, grey, cognac or white)

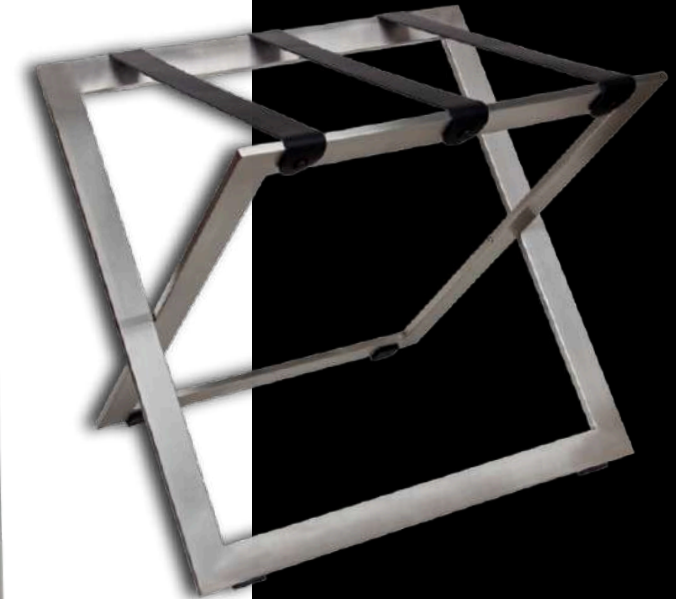

Easy to attach with 3 push buttons



dutch
design.



SCURO luggage rack

SLEEK LUGGAGE RACK WITH EXCHANGEABLE STRAPS



- Modern design, colour matt black
- Made of high-quality steel (strong and stable)
- Flat when folded up, depth only 5.5cm
- Fits your wardrobe perfectly
- Equipped with 4 floor protection gliders
- 3 strong exchangeable straps in nylon or leather
- Bespoke possibilities (customized straps with logo)
- B-TRAY plants 1 tree for every 3 luggage racks sold
- A 2-year warranty

DIMENSIONS OPEN (W x D x H)

575 x 390 x 465mm

DIMENSIONS FOLDED (W x D x H)

575 x 55 x 590mm

FRAME COLOUR

Matt black



STRAP COLOURS

Nylon (black or grey) or leather (black, grey, cognac or white)

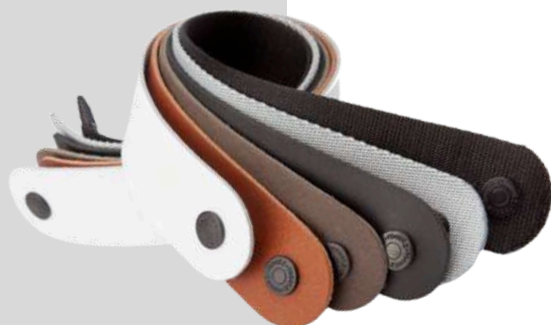

Request a quotation

SIXX luggage rack

MODERN LUGGAGE RACK WITH EXCHANGEABLE STRAPS

- Budget-friendly model
- Modern design, colour matt black
- Made of high-quality steel (strong and stable)
- Compact design; fits your wardrobe perfectly
- Equipped with 4 floor protection gliders
- 3 strong exchangeable straps in nylon or leather
- B-TRAY plants 1 tree for every 3 luggage racks sold
- A 2-year warranty

FRAME COLOUR

Matt black



STRAP COLOURS

Nylon (black or grey) or leather (black, grey, cognac or white)

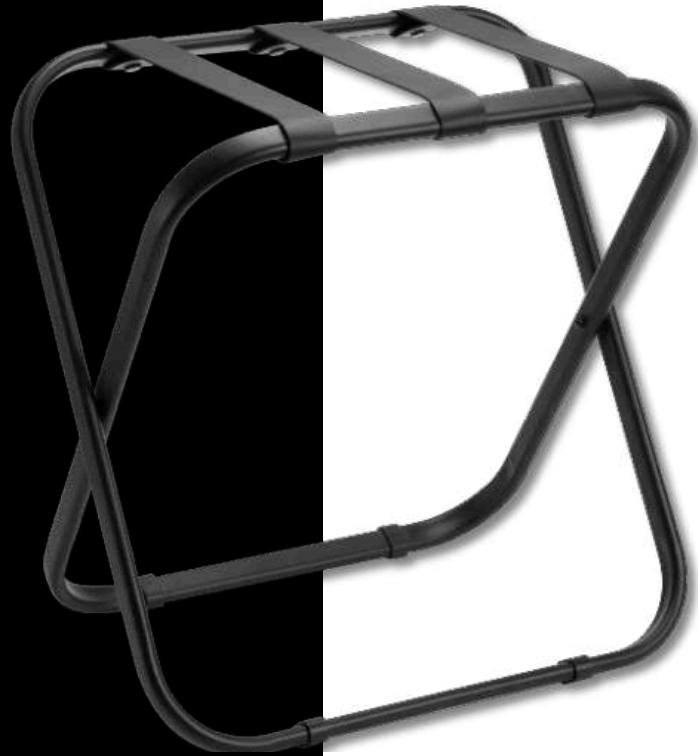

DIMENSIONS OPEN (W x D x H)

530 x 370 x 530mm

DIMENSIONS FOLDED (W x D x H)

530 x 70 x 620mm



dutch
design.



SAFARI luggage rack

BUDGET-FRIENDLY SUITCASE STAND OF STEEL

- Steel frame with 4 sturdy nylon straps
- Very compact and foldable
- Strong and stable
- Fits perfectly in the wardrobe
- Rounded corners – female shape
- B-TRAY plants 1 tree for every 3 luggage racks sold
- A 2-year warranty

[Request a quotation](#)

FRAME COLOUR

Silver, white or black



STRAP COLOUR

Black nylon



DIMENSIONS OPEN (W x D x H)

550 x 370 x 520mm

DIMENSIONS FOLDED (W x D x H)

550 x 45 x 620mm

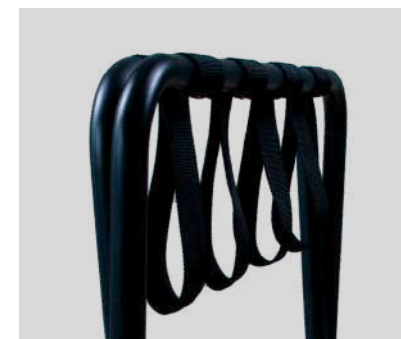



54

Other accessories

For an extra touch of comfort

B-TRAY has been your trusted partner for luxury hotel supplies for more than 17 years. Besides hospitality trays, ironing products and luggage racks, we also sell other bedroom accessories. Think of our stylish leather tissue box covers and waste bins with “green” inlay for waste separation. We also have an emergency torch with battery charger, a smart and safe device for your guests.

Are you looking for something different? We can also source hotel room accessories especially for you, such as minibars, rollaway beds or alarm clock radios.



STILO laptop safe

STEEL SAFE WITH MASTER KEY AND ADMINISTRATOR CODE

- Seamless solid steel body with rust-proof coating
- 2 solid steel locking bolts for extra security
- Easy to operate for hotel guests with 4–6-digit code
- Soft-touch blind-friendly keypad and bright red LED display
- Adjustable administrator code (6 digits)
- Auto lock after 5 minutes if user forgets to lock the safe
- Time lock in case of 3 incorrect entries
- Emergency opening with master key or administrator code
- Unlocking records available in administrator mode
- Battery powered (4x 1.5V AA, included) with low battery indicator
- Pre-drilled anchor holes for permanent mounting
- Suitable for 15 inch laptops
- With optional CEU handheld decoder
- **A 2-year warranty**



SPECIFICATIONS

Dimensions: 430 x 350 x 200mm (W x D x H)

Body thickness: 1.5mm

Door thickness: 4mm

COLOUR  Black

The STILO can hold 15-inch laptops, iPads and other important documents

INCLUDED

4 batteries (1.5V AA), 6 fixing bolts, internal carpet and master key for management

OPTIONAL

CEU handheld decoder (emergency power supply for the safe, read the data of the safe, decode the safe when the password is lost)





SWITCH desk blotter

REVERSIBLE DESIGN WITH TWO COLOURS

- Made from premium faux leather
- Can be used as a **desk blotter** or as a **welcome tray**
- Features a reversible design with one side in warm beige and the other in black, allowing customers to choose their preferred colour
- Pairs perfectly with other B-TRAY products like the SLUSH ice bucket, SWEEP/SHAPE tissue boxes, SNAP condiment box or STORE coffee capsule box
- Combines elegance with practicality, making it a perfect addition to any hospitality setting or office desk
- Water repellent and easy to clean
- A 2-year warranty



DIMENSIONS

500 x 400 x 8mm (W x D x H)

COLOUR/STRUCTURE

- Side 1: warm beige / lychee grain
- Side 2: black / smooth

mix+match

OPTIONAL

- Condiment box: SNAP or STORE (black or warm beige)
- Ice bucket: SLUSH (black or warm beige)
- Tissue box: SWEEP/SHAPE (black or warm beige)
- Kettle: STAR, STAR-BLACK, STYLE, SALSA or SOHO
- Coffee machine: START (black)
- Hotel porcelain cup: SPRING (black or white)



Mix and match

The SWITCH tray is designed to offer versatility and elegance in any setting. It can serve as a sophisticated desk blotter, providing a stylish and functional workspace. Additionally, it is perfect for presenting coffee and tea facilities, or even a tissue box holder or ice bucket.

Crafted from premium faux leather, this tray ensures durability and a luxurious appearance. Its sleek design makes it an ideal choice for both hospitality and office environments, allowing you to showcase your amenities in an organized and elegant manner.

(A smaller alternative is the SNAP main tray, available in warm beige or black.)



SWEEP tissue box

TISSUE BOX HOLDER RECTANGULAR DESIGN

- Luxurious leather look finish
- Suitable for most rectangular tissue boxes
- Ellipse opening
- Water repellent and easy to clean
- Easy to open with magnetic closing lid on the bottom
- A 2-year warranty

Request a quotation

DIMENSIONS

25.2 x 13.7 x 8.5cm (W x D x H)

COLOURS

Black or warm beige



SHAPE tissue box

TISSUE BOX COVER SQUARE DESIGN

- Luxurious leather look finish
- Suitable for most square tissue boxes
- Round opening
- Water repellent and easy to clean
- Easy to open with magnetic closing lid on the bottom
- A 2-year warranty

Request a quotation

DIMENSIONS

14 x 14 x 14.5cm (W x D x H)

COLOURS

Black or warm beige





SLUSH ice bucket

1L FAUX LEATHER ICE BUCKET WITH TONG

- Double walled bucket; keeps your ice cubes well frozen
- Perfect combination of 201 stainless steel and durable faux leather with same colour stitching
- Lid with wooden knob in matt-black finish
- Water repellent and easy to clean
- Capacity of 1 litre
- Including ice cube tong with brushed finish
- A 2-year warranty

DIMENSIONS

Diameter: 136mm

Height: 185mm

Length ice tong: 135mm

COLOURS

Black or warm beige



Pairs perfectly with other faux leather B-TRAY products!



SUMO waste bin

10L DOUBLE WALL BIN WITH LEATHER LOOK

- Dual layer hotel bin with leather look finish
- Designed to hide the bin liner and keep it in place
- Stylish and practical choice for guest rooms
- Inner bin is made of powder coated metal (black)
- Outer bin is upholstered with faux leather
- Water repellent and easy to clean
- Non-slip base for extra stability and floor protection
- A 2-year warranty

SPECIFICATIONS

Diameter: 250mm

Height: 320mm

Capacity: 10 litre

COLOURS

Black or warm beige



INCLUDED

Metal inner bin

Faux leather outer bin

(Recycle inlay is not included)



Designed to hide the bin liner and keep it in place.

Request a quotation

SUMO waste bin inlay

5L GREEN WASTE DIVIDER

- Hospitality solution for dividing the contents of a bin between general waste and recycling
- Made of Polypropylene (green)
- Fits the SUMO waste bin perfectly
- Easy to place into the waste bin
- Water repellent and easy to clean
- 8 waste separation stickers included
- A 2-year warranty

Request a quotation

SPECIFICATIONS

Dimensions: 250 x 130 x 305mm (W x D x H)

Capacity: 5 litre

COLOUR

Dark green



Fits the SUMO waste bin perfectly



Annie Leonard: "There is no such thing as 'away'. When we throw anything away it must go somewhere."



STORM emergency torch

WALL MOUNTED LED FLASHLIGHT

- Specially designed for hotel use
- Including anti-theft holder
- Easy to mount (wall, drawer or wardrobe)
- Magnetic induction switch (light switches on when you take it from the wall-mounted base, and switches off when placed back)
- Durable aluminium alloy torch with non-slip handle
- Energy saving with 13 very bright LED bulbs
- Battery powered (3x normal AA or rechargeable AA, not included)
- Including adapter for rechargeable batteries
- A 2-year warranty

[Request a quotation](#)

DIMENSIONS

Length: 175mm
Diameter: 45mm

PLUG ADAPTER

EU | UK

WEIGHT

192gr (excl. holder)





Specific requests

Looking for something special?

B-TRAY can also supply other hotel room accessories, such as minibars, folding beds, or alarm clock radios. But we can also search for products that meet very specific requirements for you.

Do you have such a request? Please do not hesitate to contact us. We are happy to help you find the right product(s)!

Telephone: +31 (0)23 542 12 12

Email: info@btray.com





64

The bathroom

Our bathroom products are stylish and functional, enhancing your guests' personal care experience. For instance, our SOLANO hair dryer comes with a retractable cord making it user friendly and easy to store, and our SCALA weighing scale is battery-free, which is practical and environmentally friendly.

Looking for something different for your hotel bathrooms? We can also source bathroom accessories especially for you, such as other hair dryers and scales, accessory holders, amenity trays, pedal bins, etc.





65

Hair dryers

The must-have for your bathrooms

Hair dryers are not only a convenient device for drying and styling hair, but also a way to enhance the quality and comfort of your hotel rooms. By providing hair dryers in your rooms, you can show your guests that you care about their needs and preferences. You can also save them the hassle of bringing their own hair dryer.

Our SOLANO hair dryer is a great choice for your hotel. B-TRAY offers this powerful and reliable device that can dry and style hair in no time. With various settings and attachments, the SOLANO can cater to different hair needs and preferences. Its sleek and elegant design suits any room decor and creates a luxury feel. Plus, it has a unique retractable cord that makes it easy and safe to store in a drawer. Guests will love this smart and practical feature that makes their stay more enjoyable.





SOLANO hair dryer

HOTEL HAIR DRYER WITH RETRACTABLE CORD



- Powerful hair dryer with dual overheating protection
- Strong 1.80m auto-rolling retractable cord
- Space saving and easy to store
- Built-in hanging loop for easy storage
- Ergonomic handle for a comfortable grip
- Perfect styling results with a slim styling nozzle
- Removable air flow filter and nozzle make cleaning quick and easy
- 3 temperatures and 2 speed settings
- Cold air setting for gentle drying
- CE, CB, GS and RoHS approved
- Optional: Luxury velvet bag for dust-free storage and wall holder
- A 2-year warranty

DIMENSIONS (WITHOUT PLUG)

L22.5 x W9.3 x H24cm (without nozzle)

L29 x W9.3 x H24cm (with nozzle)

Cable length: 1.80m

TYPE OF PLUG

EU | UK | Swiss

COLOUR  Black



dutch
design.



TECHNICAL SPECIFICATIONS

Power: 1750-2100W

Voltage: 220~240V

Frequency: 50/60Hz

Weight: 598gr

Electrical isolation: Class II

[Request a quotation](#)



SOLANO bag

VELVET STORAGE BAG FOR HAIR DRYER SOLANO

- Strong quality
- Made of luxury black velvet
- Protects your hair dryer from dust while not in use
- Fits the SOLANO hair dryer
- Two drawstrings to close the bag properly
- **A 2-year warranty**

Request a quotation



DIMENSIONS

37.5 x 28cm (L x W)

COLOUR  Black velvet

SOLANO wall holder

WALL MOUNTED HAIR DRYER SUPPORT OF STAINLESS STEEL

- Made of 304 stainless steel with matt black powder coating finish
- Plastic ring inside to protect the hair dryer from scratches
- Matches the SOLANO hair dryer perfectly
- 2 fixing screws included
- **A 2-year warranty**

Request a quotation

DIMENSIONS

92 x 135 x 55mm (W x D x H)

COLOUR  Matt black steel

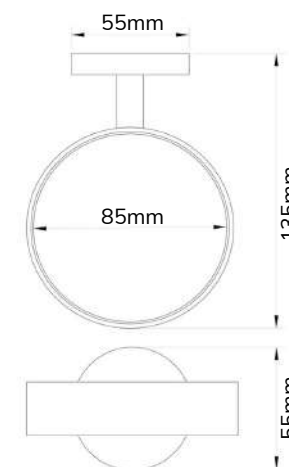



68

Weighing scales

Stylish, practical and eco friendly

One of the essential items in a hotel bathroom is a weighing scale. It's not just a practical tool for guests to monitor their weight, but it's also a sign of attention to their well-being and health. It provides an extra level of convenience and care, making guests feel more at home and their stay more cared for. With a weighing scale in the bathroom, guests can keep track of their goals, even when far from home, which contributes to a positive hotel experience.

Our SCALA weighing scale is not only very stylish, it's also an extremely practical addition to your bathrooms. Moreover, it's eco friendly. This battery-less scale is a "green" solution for hotels thanks to the unique "Push Power" Technology. When the central button is pressed, the scale uses magnetic friction to automatically charge itself. The scale is made of 5mm tempered glass with a seamless structure, making it very comfortable, safe, and hygienic for your guests.





SCALA bathroom scale

BATTERY FREE HOTEL SCALE WITH PUSH POWER TECHNOLOGY



Seamless tempered glass platform



Battery free - Push Power Technology

- Lightweight, sturdy and practical
- Push Power Technology (tap the central button to generate power)
- Environmentally friendly due to battery-free function
- Equipped with 5mm safety glass
- Seamless structure (comfortable, hygienic and easy to clean)
- Extra large, easy-to-read LCD display
- Very accurate weight measurements (precision 100g)
- Measurement units: kg and lb
- Low power indicator and overload warning
- A 2-year warranty

SPECIFICATIONS

Dimensions: 32 x 26 x 3cm (W x D x H)

Weight: 1.38kg

Maximum weight capacity: 180kg

COLOURS

Black or white



Green Power Solution



Push Power Technology



Battery Free

dutch
esign.



Request a quotation



70

Cosmetic mirrors

Shaving with a smile

A cosmetic mirror is a must-have item for any hotel bathroom. It adds a touch of luxury and convenience to your guests' experience. By offering a make-up mirror in your bathrooms, you can show your guests that you value their comfort and satisfaction. You can also spare them the trouble of bringing their own.

The SMILE mirror from B-TRAY is a perfect choice for your bathrooms. It is a durable and elegant product that is made of high-quality stainless steel with a matt-black or brushed finish. The SMILE has a clear and magnified glass (5x) that allows your guests to apply makeup, shave, or groom with ease. A great way to impress your guests with your attention to detail and comfort, as well as to create a luxurious and sophisticated atmosphere in your hotel bathrooms.



SMILE cosmetic mirror

FREE STANDING STAINLESS STEEL MIRROR

- Single side mirror with 5 magnifications
- Must-have item for any hotel bathroom
- Made of high-quality 304 stainless steel
- Fingerprint proof
- Sleek and modern design
- Angle can be changed manually with a large built-in handle
- Weighted base for extra stability
- Including double sided 3M sticker to attach the mirror to a surface and small cleaning cloth
- A 2-year warranty

COLOURS

Matt black or brushed SS



DIMENSIONS

17.1 x 12 x 33cm (W x D x H)

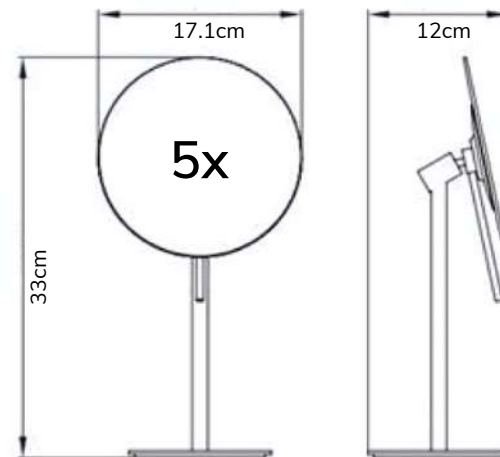



B-TRAYding Nederland BV
Laan van Vredenoord 33
2289 DA RIJSWIJK
The Netherlands

+31 (0)23 542 12 12
info@btray.com
www.btray.com

© 2025 B-TRAYding Nederland BV
All rights reserved.